

Remington Arms Company, Inc.
870 Remington Drive
PO Box 700
Madison, NC 27025-0700
(336) 548-8700
800-243-9700

REMINGTON

Arms Company, Inc.

**MOHAWK 10 C
AUTOMATIC RIFLE**

- **Shooting Safety Commandments**
- **Information**
- **Instructions for Operation & Care of Rifle**
- **Components Parts Listing**
- **Value and Reference Book Listing**

NOTE: We are pleased to accommodate your request for the Mohawk 10 C Automatic Rifle information. The following documentation represents all information available on this model from the Remington Arms Co., Inc.

DO NOT MAKE CHANGES OR ALTERATIONS TO ANY PARTS OF A FIREARM. USE ONLY REMINGTON PARTS. NEVER MAKE AN ADJUSTMENT TO THE TRIGGER, OR CHANGE THE SHAPE OR SIZE OF THE SEAR, SEAR NOTCH, OR OTHER PARTS.

Ten Commandments of Shooting Safety

1. Always keep the muzzle pointed in a safe direction.
2. Firearms should be unloaded when not in use.
3. Don't rely on your gun's "safety".
4. Be sure of your target and what is beyond it.
5. Use correct ammunition.
6. If your gun fails to fire when the trigger is pulled, handle with care!
7. Always wear eye and ear protection when shooting.
8. Be sure the barrel is clear of obstructions before shooting.
9. Do not alter or modify your gun, and have guns serviced regularly.
10. Learn the mechanical and handling characteristics of the firearm you are using.

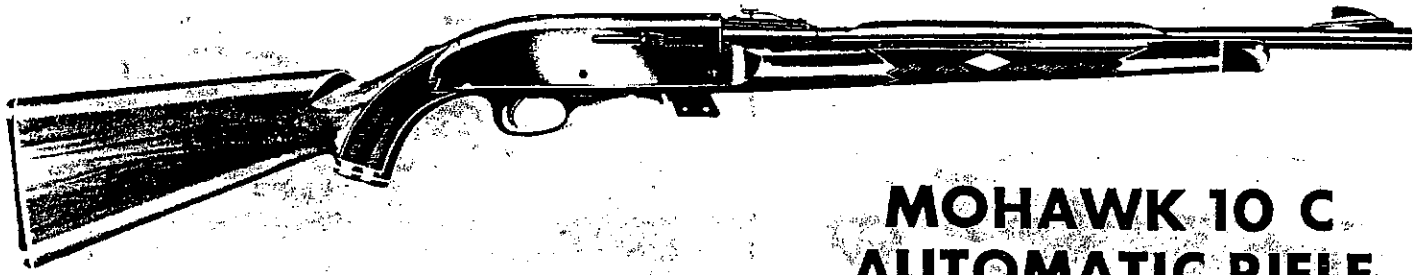

MOHAWK 10 C AUTOMATIC RIFLE

22 Caliber • Long Rifle Only
Clip Magazine — 10 Cartridge Capacity

INSTRUCTION FOLDER and PARTS LIST

THE MOHAWK 10C is a 22 caliber automatic rifle. This rifle will load and fire long rifle cartridges only. The autoloading action, after firing, will open and eject the fired cartridge case. The action then closes to cock and reload.

SAFETY — Operated by thumb at rear of receiver cover. Push rearward to **SAFE** position. **RED** indicator button will not show in **SAFE** position. The safety is designed to separate trigger from action when in **SAFE** position. Trigger in **SAFE** position is free swinging and cannot fire rifle.

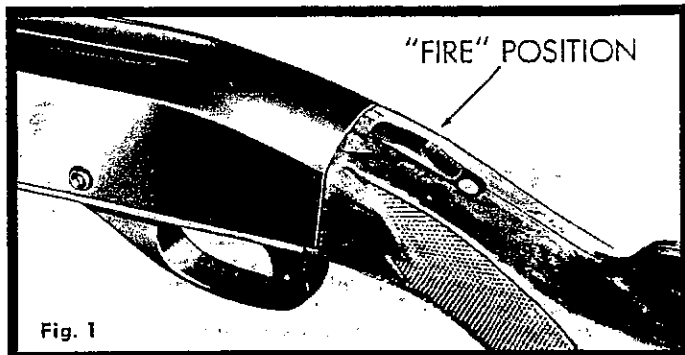

FIRE — Push safety forward to **FIRE** position (Fig. 1). **RED** indicator button will show to rear of safety in **FIRE** position. Pull trigger to fire each round loaded into barrel. After firing, the autoloading action is designed to cock the rifle after the fired cartridge case is ejected.

TO SINGLE LOAD AND COCK RIFLE — Push safety rearward to **SAFE** position. Turn ejection port in receiver upwards and drop cartridge in recess against closed action (Fig. 2). Pull bolt handle back quickly and release. Cartridge will then drop into action, and load forward into barrel.

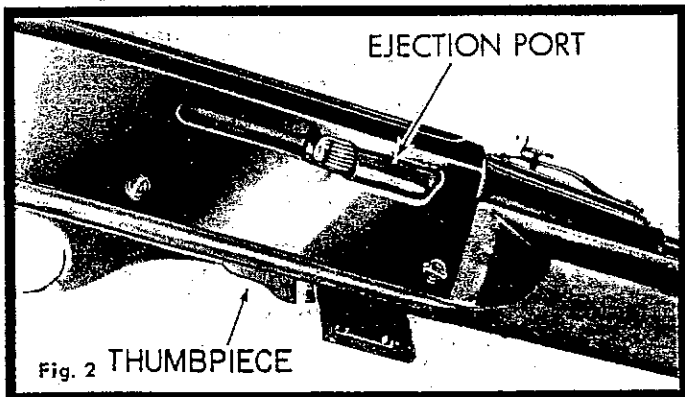

TO LOAD MAGAZINE — Clip magazine may be removed by depressing rear of magazine latch thumbpiece (Fig. 2) and pulling clip from bottom of rifle. Load cartridges into magazine. Capacity of magazine is ten (10) cartridges. To reassemble, fit channel opening on back of magazine over end of magazine guide. Push magazine upward until locked in place by magazine latch.

TO UNLOAD MAGAZINE — Magazine may be easily unloaded after being removed from rifle. Carefully slide cartridges forward and out of magazine.

Caution: After unloading, pull bolt handle back repeatedly to unload live cartridges from action or barrel chamber. Check chamber of barrel from open ejection port to make sure no live cartridge remains in chamber.

The Mohawk 10C is designed to use all the natural qualities of DuPont nylon. This material is self-lubricating and provides frictionless bearing surfaces for the free movement of the autoloading action. Therefore, cleaning and oiling is unnecessary for thousands of rounds of firing.

SIGHTS — May be adjusted for windage or range purposes by movement of rear sight. The front sight is not adjustable, and attached to the barrel by two screws. Coin fitted slots assist the operation of range screw. A stop prevents either screw from being removed from sight.

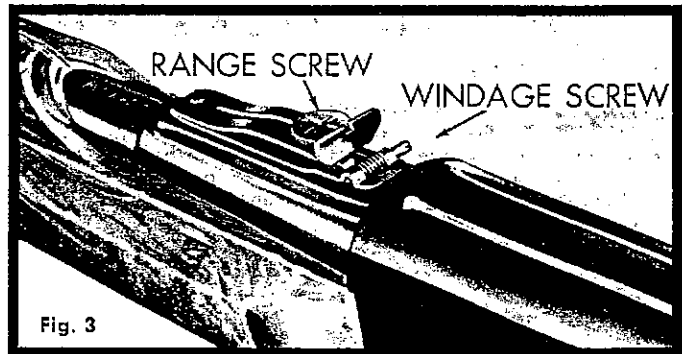

The receiver is designed with two dovetail grooves cut into the top panel for attaching the "tip-off" type of telescope mount (Fig. 3). The mount may be easily slipped into receiver grooves and tightened in desired position.

RANGE (Fig. 3) — Turn range screw clockwise to raise sight. This will raise bullet impact at target or increase range. Turn range screw counter clockwise to lower sight. This will lower bullet impact at target or decrease range.

WINDAGE (Fig. 3) — Turn windage screw clockwise to move rear sight to right. This will move bullet impact at target to right. Screw windage screw counter clockwise to move rear sight to left. This will move bullet impact at target to left.

RIFLE DISASSEMBLY AND REASSEMBLY (Fig. 4) — After extended shooting or when rifle is to be laid away for some time partial disassembly for cleaning is required. Disassemble and reassemble as directed. Cock rifle. Push safety rearward to **SAFE** position. (**RED** button will not show). Pull out bolt handle. Unscrew cover screw (2), and remove from receiver cover assembly. Slide assembly upwards and remove from rifle. Remove ejector (free fit), from exposed left side of rifle. No further disassembly of rifle is recommended unless replacement of parts is required. Reassemble parts in reverse order.

ACTION CLEANING AND CARE (Fig. 5) — Pull bolt assembly back and hold. Scrape shooting residue from cartridge feed guide and bolt rails in stock. Clean face of bolt assembly. The metallic action parts will perform best and remain clean longer if little or no oil is used. For best results do not oil Nylon parts.

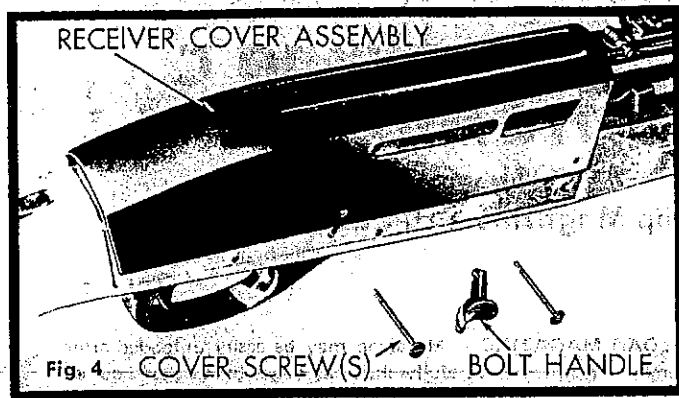

HANDLING — Use oil sparingly on metal action parts to prevent rust. Always wipe receiver cover and barrel with oiled cloth after handling. Fingers leave invisible "prints" of moisture that can cause rust to steel parts unless removed. Nylon cannot rust, therefore, no special care after handling is necessary.

EXPOSURE — After exposure to wet weather, always wipe receiver cover and barrel with oil to prevent rusting. Abrupt changes in temperature cause condensation and wetness. Therefore, special care to metal parts is required for rust prevention. When shooting in below freezing weather, remove any excess oil and use dry graphite.

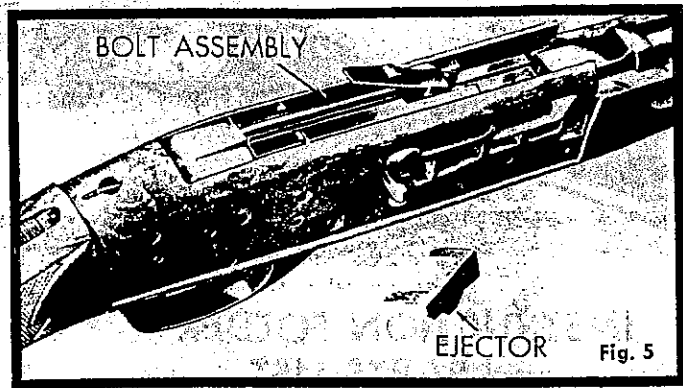

BARREL CLEANING AND CARE — Wipe bore with 22 caliber cleaning patch. Use lightly oiled patch after cleaning. Wire brush if necessary with powder solvent, then wipe clean.

MAINTENANCE — Gun should be checked periodically by a competent gunsmith to ensure proper inspection and any necessary replacement of worn or damaged parts.

IMPORTANT — This gun has been manufactured to Remington specifications and shipped from the factory suitable for use. Remington does not recommend and is not responsible for any alteration or modification to the gun not made by Remington factory personnel, nor the replacement of worn or damaged parts with those not of Remington manufacture.

INSTRUCTIONS FOR ORDERING PARTS

(Please read carefully)

WHEN ORDERING PARTS . . . MODEL NUMBER, PART NUMBER and PART NAME MUST BE GIVEN. Give also serial number (if any), and state caliber or gauge and choke needed. Please identify from the component parts, picture or section view. When ordering interchangeable shotgun barrels, please list on separate order form. This will speed up shipment to you.

Cover only one subject in letter or order. Do not order spare parts and give instructions on repair of a gun or guns in the same letter — this delays service.

Please do not ship sample parts to Firearms Factory unless it is im-

possible to identify from the Parts List or Instruction Folder. See shipping instructions concerning **FACTORY SERVICE.**

Parts will be furnished for discontinued models as long as the supply is available. We are unable to supply parts for models or repair guns not listed in Complete Line Parts List.

All parts will be shipped as ordered, but since they are made to close dimensions, the particular part may require slight adjustment or fitting to assure proper functioning of the arm.

IMPORTANT: Do not combine Part Orders with Gun Service Orders. Please send Part Orders direct to:

REMINGTON ARMS COMPANY, INC.
PARTS DEPT., ARMS SERVICE DIVISION - Ilion, New York 13357

INSTRUCTIONS FOR FACTORY SERVICE

Please read carefully before making shipment to the Firearms Plant at ILION, NEW YORK

Please package carefully when shipping firearms to factory. Use plenty of cushioning material to prevent movement of gun or gun parts in package during transit.

Please do not ship gun in a gun case, or special container that must be returned from the factory. The return of your gun or parts will be greatly speeded if properly packaged in a throw-away carton.

All shipments should have forwarding and return address clearly marked on gun package as well as on attached letter.

To further improve service — please attach complete letter of information securely on outside of each package returned to the factory for repairs.

Please do not return gun accessories such as sling straps, quick release swivels, special boots, covers, telescopes, mounts or any special equipment to the factory with the gun shipment.

Give full details of the contents of the shipment — state whether complete gun or part. List model name and model number, serial number (if any), and caliber or gauge.

Give full condition of contents — stock and fore-end damage (if any), metal damage (if any), barrel bent or damaged (if any), parts missing, etc. A full description will enable us to more accurately list the needed repairs.

Cover only one subject in letter or order. Do not order spare parts

and give instructions on repair of a gun or guns in the same letter — this delays service.

THEN — to avoid all possible delay in starting work on your gun or parts, please include in your first order or letter the trouble you wish corrected, any changes you desire, or parts you wish replaced.

If an estimate is required before the work is started, please advise. Otherwise we will proceed with the necessary work and send a statement of the cost to you. In this manner your gun or parts can be reshipped at the earliest possible date.

Unless you specify otherwise, shipments will be made by way of Parcel Post on small packages, Express on larger packages.

Remington gun parts are not interchangeable with those of any other make of gun. For this reason the Remington Arms Company, Inc. cannot service any gun not of our manufacture.

Repairs will be made on discontinued models as long as the supply of parts is available. However, repairs cannot be made for models which are not listed in Complete Line Parts List.

IMPORTANT: Before packaging guns for return to factory, ALL LIVE AMMUNITION SHOULD BE REMOVED.

If live ammunition is included in package, shipment cannot be made by Insured Mail. All other shipments may be made by Insured Mail, Express, Motor Transport, or Freight.

Please send repairs direct to:
REMINGTON ARMS COMPANY, INC.
ARMS SERVICE DIVISION - Ilion, New York 13357

COMPONENT PARTS

22 CALIBER

PRICE LIST

**MOHAWK
10 C**

AUTOMATIC RIFLE

**DISCONTINUED
NO PARTS AVAILABLE
FROM REMINGTON**

When ordering parts — Model No., Part No. and Part Name must be given.

View No.	Part No.	NAME OF PART	List Price	View No.	Part No.	NAME OF PART	List Price
1	16511	Action Spring	\$.55	28	14748	Magazine Guide	\$.50
2	16544	Action Spring Plunger35	29	14354	Magazine Guide Screw35
3	16570	Barrel	11.40	30	14351	Magazine Latch90
4	15045	Barrel Bracket	1.00	31	14957	Magazine Latch Thumbpiece35
	25640	Barrel Bracket Assembly (includes Barrel Bracket, Barrel Support)	1.30	32	16748	Rear Cover Screw Bushing35
5	15046	Barrel Support35		24400	Rear Sight Assembly (includes Rear Sight, Elevation Screw, Elevation Screw Washer).....	1.30
6	16512	Barrel Lock Screw.....	.55	33	16528	Rear Sight Rivet35
7	31620	Bolt Sub Assembly	6.25	34	24410	Receiver Cover Assembly (includes Cartridge Feed Guide Spring, Cartridge Feed Guide Spring Rivet, Receiver Cover Screw Lug (2), Receiver Cover Shell, Rear Sight, Rear Sight Rivet, Elevation Screw, Elevation Screw Washer, Windage Screw)	6.85
	24391	Bolt Assembly (includes Bolt Sub Assembly, Bolt Guide, Cartridge Feed Guide, Extractor, Extractor Plunger, Extractor Spring, Firing Pin, Firing Pin Retaining Pin, Firing Pin Retractor Spring, Firing Pin Stop Pin).....	8.30	35	16530	Safety35
8	16550	Bolt Handle35		24405	Safety Lever Assembly80
9	16547	Cartridge Feed Guide55	36	16566	Safety Lever35
	24415	Cartridge Feed Guide Spring Assembly (includes Cartridge Feed Guide Spring, Cartridge Feed Guide Spring Rivet)	4.15	37	16541	Safety Lever Cam Pin35
10	16515	Cover Screw (2)55	38	16531	Safety Lever Pin35
11	16564	Disconnecter	1.00	39	23224	Safety Detent Ball35
	25000	Disconnecter Assembly	2.55	40	16542	Safety Detent Retaining Pin35
12	16565	Disconnecter Pivot	1.00	41	16533	Safety Detent Spring35
13	16516	Disconnecter Pivot Spring55	42	16567	Sear	1.30
14	16541	Disconnecter Pivot Pin.....	.35	43	16534	Sear Assembly Pin35
15	15994	Ejector80	44	16559	Sear Spring35
	16526	Elevation Screw (Range)55	45	31625	Stock Assembly (includes Butt Plate, Butt Plate Spacer, Diamond Inlay—Right, Diamond Inlay—Left, Fore-end Tip, Fore-end Tip Spacer, Grip Cap, Grip Cap Spacer, Magazine Guide Nut, Stock Bolt (3), Stock—Right Half, Stock—Left Half, Stock Filler, Stock Nut (3)).....	20.70
	16527	Elevation Screw Washer35				
16	18408	Extractor80	46	16540	Striker Spring Sleeve80
17	17667	Extractor Plunger35	47	16568	Trigger Complete (includes Trigger Cap)	1.40
18	15006	Extractor Spring35	48	16541	Trigger Assembly Pin35
19	28185	Firing Pin	1.00	49	14349	Trigger Guard	1.15
	28186	Firing Pin (size 6)	1.00	50	16541	Trigger Guard Assembly Pin.....	.35
	28184	Firing Pin (size 4)	1.00	51	16517	Trigger Spring55
20	16549	Firing Pin Retaining Pin35	52	16529	Windage Screw.....	.55
21	16513	Firing Pin Retractor Spring.....	.35			ACCESSORIES (Not Shown)	
	16514	Firing Pin Stop Pin35		25886	Sling Strap Assembly	3.80
22	16554	Firing Pin Striker	1.40		15055	Sling Retaining Screw (need 4)30
23	16520	Firing Pin Striker Spring55		15050	Sling Swivel Retainer (need 2)60
24	16545	Front Sight	1.90		26170	Sling Strap Assembly and Mountings Complete (includes Sling Strap Assembly, Sling Swivel Retainer (2), Swivel Retaining Screw (4)).....	6.20
25	16892	Front Sight Screw (2).....	.35				
26	16968	Front Sight Washer (2)35				
27	32341	Magazine Assembly, 10 - Shot.....	4.00				

EXPLODED VIEW

MOHAWK

22 CALIBER AUTOMATIC RIFLE

10 C

REPLACEMENT PARTS: Parts may be identified from the Exploded View.

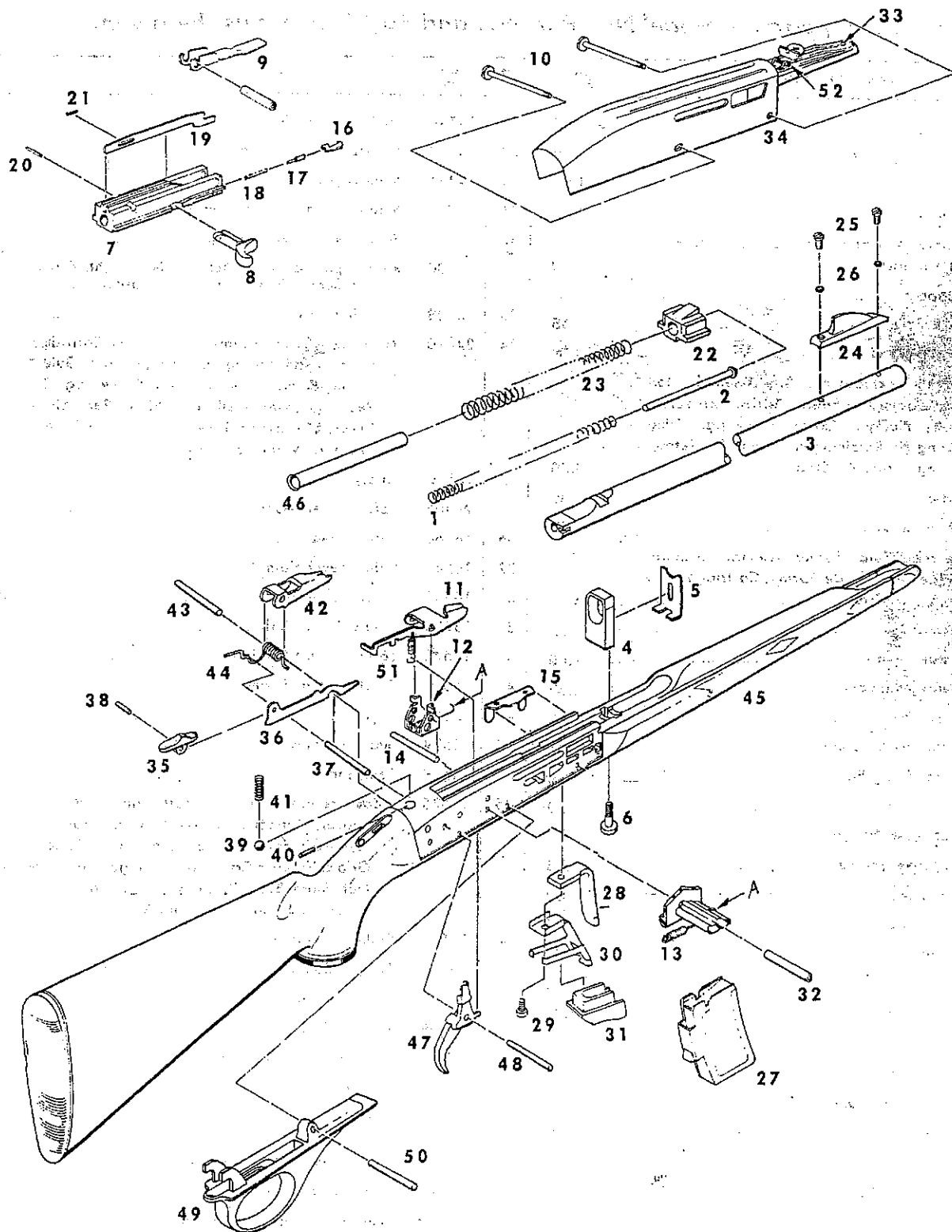

Send all guns for factory service and inquiries on service and parts to
REMINGTON ARMS COMPANY, INC.
Arms Service Division
Ilion, New York 13357

All other inquiries are to be addressed to
REMINGTON ARMS COMPANY, INC.
Bridgeport, Connecticut 06602

Firearms Value & Reference Books

NOTE: We do not provide information on firearms' values. You may want to have your firearm appraised by a gunsmith. The following sources may also be helpful. We do not accept responsibility for the goods or services provided by these sources.

Firearms Value Books

Blue Book of Gun Values

Blue Book Publications
8009 34th Avenue South #175
Minneapolis, MN 55425
800-877-GUNS

Flayderman's Guide to Firearm Values Gun List

Modern Gun Values
Krause Publications
700 East State Street
Iola, WI 54990-0001
847-573-8530

Gun Trader's Guide

Stoeger Publishing Company
5 Mansard Court
Wayne, NJ 07470
973-872-9500

Reference Books

The Remington 700

John Flacy
Brownells, Inc.
200 South Front Street
Montezuma, IA 50171
515-623-5401

Cartridges of the World

Frank C. Barnes
Standard Catalog of Firearms
Krause Publications
700 East State Street
Iola, WI 54990-0001
847-573-8530

Shooter's Bible

Stoeger Publishing Company
5 Mansard Court
Wayne, NJ 07470
973-872-9500

Remington, America's Oldest Gunmaker

Remington Arms Co.
PO Box 700
Madison, NC 27025
Attention: History Book
800-423-8495

... ..

...

... ..

... ..

... ..

...

... ..

... ..

... ..

... ..