

Owner's Manual

Instruction Book for:
MODEL 700 ETRONX
BOLT ACTION CENTERFIRE RIFLE

Remington®

IMPORTANT!

READ ALL INSTRUCTIONS
AND WARNINGS IN THIS
BOOK BEFORE USING THE FIREARM.



PAGE 2.....THE TEN COMMANDMENTS OF
FIREARM SAFETY

PAGE 9.....IMPORTANT PARTS OF THE FIREARM

PAGE 13.....HOW TO LOAD AND UNLOAD

PAGE 14.....LUBRICATION AND MAINTENANCE

PAGE 17.....HOW TO OBTAIN PARTS AND SERVICE

A Tradition of Performance and Safety.

In 1816 Eliphalet Remington was confident he could make a flintlock that was as good or better than any he could buy. His confidence was well founded. The barrel he handcrafted set a new standard for firearm accuracy and spawned generations of products that have made Remington® Arms America's leading gunmaker. While performance and style are certainly hallmarks of Remington firearms, one factor ultimately drives their performance. Safety. Eliphalet Remington never lost sight of the fact that his rifles were potentially lethal and could kill someone if handled improperly. And after more than 180 years the same holds true for any firearm, including your new Remington. Eliphalet Remington's first flintlock launched a proud tradition of accuracy and responsibility.



Eliphalet Remington's first flintlock launched a proud tradition of accuracy & responsibility.

Safety is Critical to Performance.

A superbly crafted gun is only as good as the hands that hold it. You can never be too careful. Shooting accidents are often caused by careless oversights such as failing to control the direction of the muzzle, failing to fully engage the safety, leaving ammunition in the chamber or using improper loads. These oversights can result in the destruction of life, limb or property. There's no calling back a bullet once it's been fired, so it's critical that you know the principles of safe gun handling and storage before you ever take your new Remington firearm out of the box.

The proper use and performance of your firearm depends on correct assembly and maintenance, so it's critical that you familiarize yourself with the information in this instruction book. Even if you're a veteran shooter with a collection of Remington firearms, take the time to read this literature. Not all firearms are the same. That means the first step in safe handling is to learn the features and requirements of your new Remington.

THE TEN COMMANDMENTS OF FIREARM SAFETY

The Ten Commandments of Firearm Safety should be etched in your memory forever. Let them govern your action wherever and whenever you're involved with firearms. In the field. On the range. Or in your home. Please take the time to review and understand these rules.

1st COMMANDMENT

Always Keep the Muzzle Pointed in a Safe Direction.

This is the most important gun safety rule. A safe direction is one in which an accidental discharge will not cause injury to yourself or others. Never allow your gun to point at anything you don't intend to shoot. Be especially careful when you're loading or unloading. Treat every gun as if it were loaded. And make it a habit to know where the muzzle is pointed at all times, even when your firearm is unloaded. No one will be injured by an accidental discharge if you keep your firearm pointed in a safe direction. It's as simple as that.



2nd COMMANDMENT

Firearms Should be Unloaded When Not Actually in Use.

Load your firearm only when you're in the field or on the target range and ready to fire. Never let a loaded gun out of your sight or out of your hands. Unload it as soon as you're finished shooting – before you bring it into your car, camp or home. Remember, unloading your firearm means unloading it completely, so there is no ammunition in the chamber or in the magazine. Before handling a firearm or passing it to someone else, visually check the chamber, receiver and magazine to be certain they do not contain ammunition. Always keep the gun's action open when not in use. Never assume a gun is unloaded even if you were the last person to use it. Always check for yourself.

Let common sense rule when you carry a loaded gun. If you're in a situation that could risk accidental discharge – such as crossing a fence, wading through a stream or climbing a tree – always unload your gun. Never pull or push a loaded firearm toward yourself or another person. And never carry a loaded gun in a scabbard, detached holster or gun case.

Certain firearms (including some Remington® rifles and shotguns) are equipped with internal security devices to prevent unauthorized use. In addition, some firearms owners use external devices, such as cable locks and trigger blocks, for the same purpose. Even if you use such a device, you should still keep your firearm unloaded when stored or not in use. And using internal or external devices cannot substitute, however, for securing your firearms and ammunition in a separate, locked location.

Safe storage of firearms is just as critical as safe handling. Never store guns loaded. Be sure to keep your firearms in a secure place where unauthorized persons cannot get their hands on them without your knowledge.

Take special care if there are children around. Kids are fascinated by guns. It's a natural curiosity that can have tragic consequences when not properly supervised. Store your firearms in a locked gun safe or some other location that physically bars a child from gaining access.

Ammunition should be stored and locked in a location separate from your firearm. Never leave an unsecured firearm or ammunition in a closet, dresser drawer or under the bed. Remember, it is your responsibility to make sure that children and others unfamiliar with firearms cannot get access to your firearm and ammunition.



Firearms should be stored in a secure place where children cannot access them. A gun safe is an ideal way to secure your firearm.

3rd COMMANDMENT

Don't Rely on Your Gun's Safety.

Treat every gun as if it can fire at any time, whether or not there's pressure on the trigger. Your firearm has been carefully designed to maximize performance and safety. However, because a gun's safety is a mechanical device, it could fail.

Human error is a more likely reason for a gun safety to fail. By mistake, you may think the safety is on when it really isn't. Or the safety may have been disengaged without your knowledge. Or you could think your gun is unloaded when there's actually a cartridge or shell in it. A mechanical safety is not a substitute for common sense. It's merely a supplement to your proper handling of a firearm.

Never touch the trigger on a firearm until you are ready to shoot. Keep your fingers away from the trigger when you're loading or unloading. And don't pull the trigger when the safety is engaged or positioned between safe and fire.

Before using your gun, read this instruction book to understand the exact location and operation of your firearm's safety. Even when the safety is on, maintain control of your loaded firearm and control the direction of the muzzle. In other words, don't rely on your safety to justify careless handling. If your firearm's internal mechanisms are broken or have been altered, your firearm may fire even when the safety is on. Remember, you and your safe gun handling practices are your gun's best safety.

4th COMMANDMENT

Be Sure of Your Target and What's Beyond It.

You can't stop a shot in mid-air, so never fire unless you know exactly where your shot is going and what it will strike. Never fire at a sound, a movement or a patch of color. A hunter in camouflage can easily be mistaken for a target by an impulsive shooter. Before you pull the trigger be absolutely sure of your target and what's behind it. Make sure

the shot has a backstop such as a hillside or dense material like sand. Remember, bullets can travel great distances with tremendous velocity. Know how far your shot will go if you miss your target or the bullet ricochets.

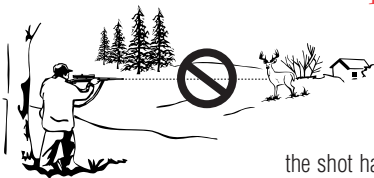

Use Proper Ammunition.

Every firearm is designed to use a certain caliber or gauge of ammunition. Using the wrong ammunition, mixing ammunition or using improperly reloaded ammunition can cause serious personal injury or death. And it only takes one cartridge or shotshell of the incorrect caliber or gauge, or which has been improperly reloaded, to destroy your firearm. It's your responsibility to make sure the ammunition you use exactly matches the caliber or gauge of your gun. Refer to this instruction book to find out the specific requirements of your firearm. Always read and heed the instructions on ammunition boxes.

Confusing shells or cartridges can cause serious personal injury or death and destroy your firearm. Examine your shells or cartridges closely and use only the precise caliber or gauge for your specific firearm. For example, suppose you accidentally loaded a 20 ga. shell into a 12 ga. shotgun. Because the 20 ga. shell is too small for the chamber, the 20 ga. shell could travel down the barrel and get lodged in the bore. If you then loaded a standard 12 ga. shell behind it and fired, the 12 ga. shot will slam into the lodged 20 ga. shell and may cause the barrel to explode right in your hand. This is commonly called a 12/20 burst, and it can kill you.

Check all ammunition before you load it to make sure it matches your gun's requirements. Every Remington® cartridge and shell is head-stamped with its caliber or gauge for easy identification. Likewise, you'll find the caliber or gauge of your new Remington firearm imprinted on the barrel.

Reloading Requires Extra Diligence.

If you're an ammunition reloader, you are responsible for personally assuring that the loads and components of your reloaded ammunition meet your gun's factory-tested standards. Never use ammunition which has been reloaded by someone else!

Many shooters handload as a hobby or to save money on commercial, factory-made ammunition. However, it requires a thorough knowledge of reloading procedures and a deep respect for the explosive potential of gunpowder.

Firearms are designed, manufactured and proof-tested to standards based on factory-loaded ammunition. Handloaded or reloaded ammunition that deviates, either intentionally or accidentally, from load or component recommendations can be very dangerous.

Reloaders must observe all possible safety precautions and practices related to the proper handling of explosives. Whether you're a seasoned reloader or just starting out, you should study the subject, watch reloading demonstrations and talk to experienced reloaders.

The first rule of reloading is to always follow the manufacturer's instructions for the components you're using. They'll tell you to follow certain guidelines. Namely:

1. Don't mix or substitute powders or primers.
2. Don't use unknown or substandard components.
3. Use only suitable components that have been factory-tested by reputable ammunition, powder and bullet manufacturers.
4. Always be sure to use the manufacturer's recommended recipe when reloading.

Not following these guidelines could result in severe injury to yourself or severe damage to your firearm. Dangerously high pressure and explosions can result from an overcharge of powder or other deviations from established reloading guidelines. Be very careful. The process of reloading exposes you to environmentally hazardous material. Lead, which is known to cause cancer and birth defects, is the most common substance in bullets and shot. It is important to handle lead bullets and shot with extreme care. Work only in a well-ventilated area and always wash your hands after exposure and before eating. Never smoke while reloading.

Primers and powders are also highly toxic and flammable. So after reloading be sure to clean up all materials from your work area. Don't leave primer or powder spills anywhere on the floor or bench top. Dispose of all waste material in accordance with the manufacturer's recommendations.

Finally, when reloading or handloading concentrate on what you're doing at all times. Do not be distracted by talking to others, listening to the radio or watching TV while reloading. Never reload after consuming alcoholic beverages or drugs of any kind. You are working with extremely hazardous materials and you can't risk even a few seconds of distraction. Remember, if you reload, you are the ammunition manufacturer and you are responsible for the performance and safety of your reloaded ammunition.

6th COMMANDMENT

If Your Gun Fails to Fire When the Trigger is Pulled, Handle With Care.

If for some reason the ammunition doesn't fire when you pull the trigger, stop and remember the 1st Commandment of Firearm Safety – always keep the muzzle pointed in a safe direction. Keep your face away from the breech, then put the safety on, carefully open the action, unload the firearm and dispose of the cartridge safely. Remember that anytime there's a shell in the chamber, your gun is loaded and ready to use. Even if you tried to shoot and your gun didn't fire, treat your firearm as if it could still discharge.

7th COMMANDMENT

Always Wear Eye and Ear Protection When Shooting.

Your sight and hearing risk injury from shooting and should be protected at all times. Wear protective shooting glasses to guard against falling shot, clay target chips, powder residue, ruptured cartridge cases and even twigs and branches in the field. Also be sure to wear eye protection when you're disassembling or cleaning a gun so that tensioned parts (like springs) and cleaning solvents don't come in contact with your eyes. Continued exposure to shooting noise can permanently damage your hearing. On the range, where shooting volume is the loudest, be sure to use the maximum protection of a headset. And learn to use ear protection in the field, especially in confined locations like duck blinds.



8th COMMANDMENT

Be Sure the Barrel is Clear of Obstructions Before Shooting.

Before loading your gun, open the action and make sure there's no ammunition in the chamber or magazine. Check the barrel for any obstructions or debris. Even a small amount of snow, mud, excess lubricant or grease in the bore can dangerously increase pressure and cause the barrel to bulge or burst when firing. Use a cleaning rod and patch to wipe away anti-rust compounds or any other residues or obstructions in the barrel. Never try to shoot out an obstruction by loading another shell and firing!

When firing, rely on your instincts. If the noise or recoil of your firearm seems weak, stop everything, unload your firearm and be sure nothing is lodged in the barrel. Remember the 12/20 burst? That's what can happen when the barrel is obstructed. So always be sure you're using the correct ammunition in your firearm and that it's free of obstructions.

9th COMMANDMENT

Don't Alter or Modify Your Gun and Have it Serviced Regularly.

Your firearm has been designed to operate according to certain factory specifications. You'll jeopardize your safety and that of others around you by attempting to alter its trigger, mechanical safety or other mechanisms. So never alter or modify your firearm in any way.

Like any mechanical device, a firearm is subject to wear. It must be maintained and periodically serviced to assure optimum safety and performance. Only a qualified service facility should service, repair or modify your Remington® firearm. Consult your instruction book for instructions on how to send your firearm to the factory or for the location of the nearest Remington repair station.

Proper cleaning and lubrication are also important to firearm maintenance and are necessary to assure accuracy, safety and reliability. Before cleaning, always make sure that your gun is completely unloaded. And always clean the barrel from the chamber end to the muzzle when possible.



Make it a practice to clean your bore every time you're going to shoot. Be sure to clean your entire gun before and after long-term storage and no less than once a year. It's also important to clean your gun whenever it's been exposed to adverse conditions such as rain, dirt, mud, snow, sleet or saltwater.

For safe and dependable operation of your firearm, all parts of your gun must be properly cleaned and lubricated. Periodically inspect the internal workings of your firearm to be sure they're clean and free of rust, unwanted dirt and debris.

Use recommended lubricants on your gun and do not over-lubricate. Excessive use of a non-recommended lubricant could adversely affect the function and safe operation of your firearm. Remember, you are responsible for the proper care and maintenance of your firearm. Failure to properly maintain your firearm can not only damage or ruin your firearm, it can expose you and others to unnecessary risks of personal injury or death.

Remington® has a wide range of firearm care products and resources for best results when cleaning your gun. Everything from solvents and lubricants to rods and patches. They're all available from your Remington dealer.

10th COMMANDMENT

Learn the Mechanics and Handling Characteristics of Your Firearm.

Not all guns are alike. They have different mechanical characteristics that dictate how you should carry and handle them. Anyone who plans to use a firearm should first become totally familiar with the type of firearm it is and the safe handling procedures for loading, unloading, carrying, shooting and storing it.

Before you even unpack your new Remington firearm, read this instruction book from cover to cover and familiarize yourself with the different component parts of the gun. Then read, understand and follow the Ten Commandments of Firearm Safety in this book.

WARNING! Discharging firearms in poorly ventilated areas, cleaning firearms or handling ammunition may result in exposure to lead, a substance known to cause birth defects, reproductive harm, cancer and other serious physical injury. Have adequate ventilation at all times. Wash hands thoroughly after exposure.



SHOOT SOBER!!

There's one other rule that must be followed when handling firearms. In fact, respect for this rule is necessary in order to effectively practice the Ten Commandments of Firearm Safety. The rule is: SHOOT SOBER! Guns and alcohol or drugs make a deadly combination. Never consume anything that would mildly impair your judgment or physical coordination when you're using a firearm. A staggering percentage of the shooting accidents that occur every year involve alcohol or drugs. Be smart. Always shoot sober and stay alive.

WARNING! Failure to follow any of these safety rules may cause personal injury or death to the shooter or bystander and damage to property. Do not use a firearm until you fully understand and practice the Ten Commandments of Firearm Safety. If you have any questions about the safe use of a Remington firearm, write to us at Remington Arms Company, Inc., Consumer Service, P.O. Box 700, Madison, NC 27025-0700, or call us at 1-800-243-9700.

DON'T KEEP THIS TO YOURSELF.

Now that you're a gun owner you have the obligation to help ensure that shooting sports are safe for everyone – participants and bystanders alike. You can do that by practicing these principles of firearm safety and passing them on to others – especially new shooters. Set an example for beginners. Be a guide to their safe entry into the exciting world of shooting sports. Invest your time and patience for the love of the sport and for its future. After all, it's your love of the sport that led you to buy a new Remington.

Firearm ownership is a right and privilege. It's a right guaranteed in this nation's Constitution. It's a privilege which carries with it a personal responsibility to use your firearm in a way which will ensure your safety and the safety of others. The preservation of this right and privilege depends on the personal commitment of you and your fellow shooters to the safe and responsible use of firearms. Let the Ten Commandments of Firearm Safety outlined in the book guide you at all times. Teach and promote these rules whenever you can. Remember, firearm safety depends on you! That's the only way to really enjoy your new Remington firearm and to preserve sport shooting as we know it today.

NOTE: This equipment has been tested and found to comply with the limits for a Class B digital device, pursuant to part 15 of the FCC Rules. These limits are designed to provide reasonable protection against harmful interference in a residential installation. This equipment generates, uses and can radiate radio frequency energy and, if not installed and used in accordance with the instructions, may cause harmful interference to radio communications. However, there is no guarantee that interference will not occur in a particular installation. If this equipment does cause harmful interference to radio or television reception, which can be determined by turning the equipment off and on, the user is encouraged to try to correct the interference by one or more of the following measures:

- Reorient or relocate the receiving antenna.
- Increase the separation between the equipment and receiver.
- Consult the dealer or an experienced radio/TV technician for help.

CAUTION: Any modification to this product not expressly approved by Remington® Arms could void the user's authority to operate the equipment.

Remington Model 700™ ETRONX™ Bolt Action Rifle

Congratulations on your choice of a Remington. With proper care, it should give you many years of dependable use and enjoyment. For best results, we recommend that you use Remington EtronX Ammunition – the ammunition used in factory testing your firearm against our exacting function and performance standards.

PICTURE 1 This picture shows the main parts of a REMINGTON AUTOLOADING RIFLE. The picture will aid in understanding the instructions in this book.

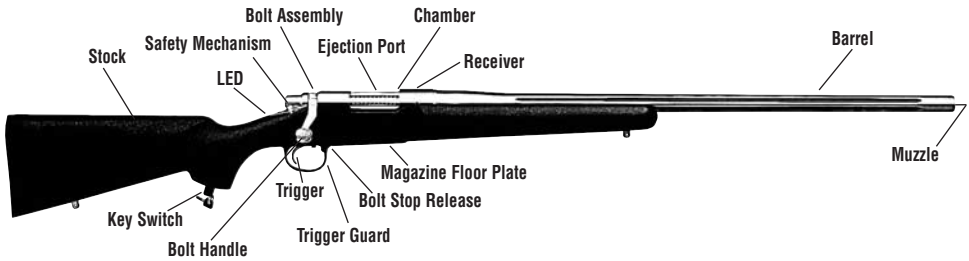

NOTE: This firearm is designed for use with Remington electric primed EtronX ammunition ONLY.

ETRONX AMMUNITION U.S. Patent 5,646,367 Other Patents Pending

PICTURE 2 This picture shows the parts of the ammunition.

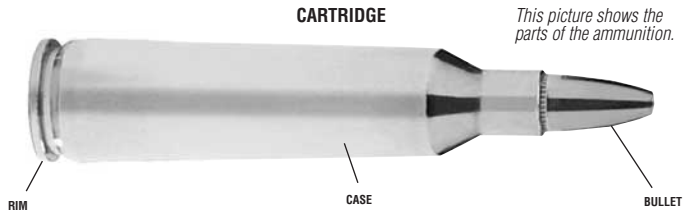

Firearm Safety

A person using any firearm has assumed an enormous responsibility. You must use your firearm in a way that will ensure not only your own safety, but that of others. Safe gun handling is not a part-time or occasional requirement – it is a full-time responsibility. You must know how to use your firearm safely at all times, under all circumstances. Never use any firearm without a complete understanding of how it works and how to use it safely.

This instruction book is intended to help you learn how to properly and safely use and care for your Remington firearm. Only when you understand and can safely practice all of the instructions in this book should you begin to use the firearm with live ammunition.

For the safety of the shooter and bystanders, if you loan or sell this firearm, this book must accompany the firearm.

If you have any questions concerning the safe use of your Remington firearm, write to us at Remington Arms Company, Inc., Consumer Affairs Division, P.O. Box 700, 870 Remington Drive, Madison, North Carolina 27025 or call toll-free 1-800-243-9700.

Model 700™ ETRONX™ Technology Overview

The Model 700 EtronX rifle represents the latest development in firearms and ammunition technologies. Outwardly, the Model 700 EtronX looks and feels like a standard Model 700. In fact, the rifle shares many of the same components with the Model 700. Internally, however, the Model 700 EtronX utilizes a new, patented technology to fire electric primed Remington® EtronX ammunition. Where a standard Model 700 and other conventional firearms utilize the impact of a firing pin on a percussion primer to ignite the cartridge's powder, the electronic ignition system of the Model 700 EtronX uses an electrical pulse to accomplish the same action with electric primed EtronX ammunition.

The electronics that generate the electrical firing pulse are also used to control the operation of the firearm. The firearm's electronics:

- Monitor the position of the safety mechanism and key switch.
- Control the firing of the firearm so that a fire pulse is generated only if certain predetermined conditions are met.
- Check for the presence of a round of ammunition in the rifle's chamber when the firearm is in the ready-to-fire state (round present sensing).
- Self-monitor the state and condition of the electronics.
- Monitor the battery's voltage.
- Communicate the operating condition of the firearm to the shooter through the **LED (Light Emitting Diode)** mounted in the top of the stock just behind the receiver tang.

Depending upon the conditions detected by the firearm's electronics, the **LED** may be (i) **OFF** (not illuminated), (ii) turned **ON** solid or (iii) flashing a status code.

To conserve energy, the Model 700 EtronX was designed to put itself into a lower power consumption mode after certain periods of inactivity. To reactivate the firearm after it has gone into a low power consumption mode, it is necessary to cycle the safety mechanism from the **S-SAFE** to the **F-FIRE** position.

As with all firearms, it is important that the ammunition used exactly matches the caliber or gauge markings on your firearm. With the introduction of electric primed ammunition, it is also important that the ammunition's primer is compatible with the firearm in which it is being used. Electric primed Remington EtronX ammunition is physically identical to conventional ammunition with the exception of the primer. See Picture 2. The EtronX electric primer is visibly distinct and different from a conventional primer by virtue of a circular contact in the center of the primer. The Model 700 EtronX is designed to function with the electric primed EtronX ammunition only.

A troubleshooting guide for the Model 700 EtronX is included beginning on page 20 of this instruction book. The troubleshooting guide, in conjunction with this instruction book, should answer most questions you may have about your rifle and its operations.

U.S. Patents 5,755,056; 5,779,433; 5,806,266; 5,987,798 and other Patents Pending.

The Operating Sequence

The operating sequence of the Model 700 EtronX is as follows:

- Enable the firearm by turning the key switch until it is in-line with the barrel. The key slot will be pointing at the **ON** symbol (**I**) on the key switch.
- When the safety mechanism is moved to the **F-FIRE** position without a cartridge chambered, the **LED (Light Emitting Diode)** will flash a status code if one is pending (e.g. low battery), or will remain **OFF** until a cartridge is loaded and sensed present in the closed and locked chamber.
- When a cartridge is loaded and sensed present by the firearm's electronics in the closed and locked chamber and the safety mechanism is in the **F-FIRE** position, the **LED** turns **ON** solid and the firearm is ready to fire.
- When the trigger is pulled, the chambered round is fired and the **LED** is turned **OFF**.
- When the fired cartridge is ejected and another cartridge is chambered and sensed present by the firearm's electronics (with the safety mechanism in the **F-FIRE** position), the **LED** turns **ON** solid. If the cartridge is removed from the chamber, the firearm's electronics sense the round is no longer present and turns the **LED OFF**.
- When the safety mechanism is moved to the **F-FIRE** position with a cartridge chambered, it takes approximately 1/2 second for the **LED** to turn **ON** solid, indicating the rifle is ready to fire.
- After a cartridge is sensed present and the safety mechanism remains in the **F-FIRE** position, cartridges can be fired every 0.6 seconds.

- Whenever the **LED** is turned **ON** solid, the firearm is ready to fire.
- If the firearm has gone into the low power consumption mode, cycle the safety mechanism to the **S-SAFE** position and then to the **F-FIRE** position to reactivate the firearm.
- When you are finished shooting, disable the firearm by: (1) moving the safety mechanism to the **S-SAFE** position; (2) turning the key switch until it is perpendicular to the barrel such that the key switch will be pointing at the **OFF** symbol (**O**) on the key switch and (3) unloading all ammunition from the magazine and chamber.

A troubleshooting guide for the Model 700™ EtronX™ is included beginning on page 20 of this instruction book. The troubleshooting guide, in conjunction with this instruction book, should answer most questions you may have about your rifle and its operation.

Important Parts of the Firearm

The Safety Mechanism

The safety mechanism provides protection against accidental or unintentional discharge under normal usage when properly engaged and in good working order.

To engage the safety mechanism, put it in the **S-SAFE** position. See Picture 3.

Always put the safety mechanism in the **S-SAFE** position before handling, loading, unloading or disassembling the firearm.

When you are ready to fire the firearm, put the safety mechanism in the **F-FIRE** position to disengage the safety mechanism. See Picture 4.

Do not touch the trigger while moving the safety mechanism. Your fingers and all other objects should be kept outside of the trigger guard and away from the trigger until you are actually ready to fire by pulling the trigger.

Never pull the trigger when the safety mechanism is in the **S-SAFE** position.

WARNING: If the **LED** is turned **ON** solid, the firearm will fire when the trigger is pulled.

Even when you think the safety mechanism is in the **S-SAFE** position, careless handling can cause the firearm to fire. See the TEN COMMANDMENTS OF FIREARM SAFETY on page 2.

The Key Switch

The key switch is located in the bottom of the pistol grip. See Picture 5. The key switch is used to both enable and disable the electronic system.

WARNING: The key switch should always be in the **OFF/DISABLED (O)** position and the key removed and stored separately whenever the firearm is not in use.

WARNING: The key switch should always be in the **OFF/DISABLED** position until you are ready to use the firearm. See Picture 5.

The key switch **MUST** be in the **ON/ENABLED (I)** position before using the firearm. The key switch is in the **ON/ENABLED** position when the key switch is in-line with the barrel. See Picture 5.

The key can be removed from the key switch in either the **OFF/DISABLED (O)** or **ON/ENABLED (I)** position.

The Light Emitting Diode

The **LED** is located on the top of the stock just to the rear of the receiver. See Picture 6.

The system status of the firearm is communicated to the user through flashes on the **LED**. There is a two (2) second delay after each string of flashes and then the status code is repeated.

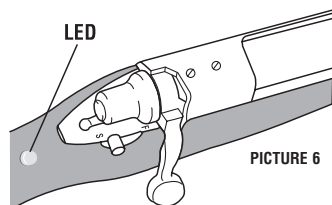
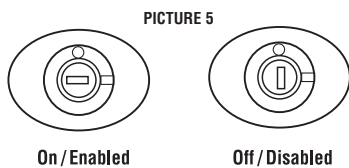
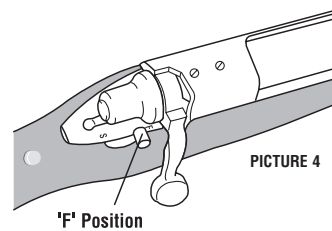
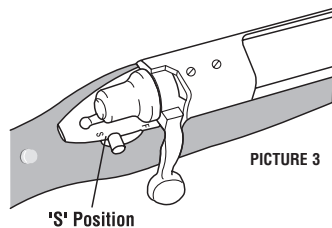

The LED flashes are described as follows:

- **LED ON** solid = Firearm is ready to fire.
- 1 Flash = Battery Low 1 (The battery's voltage is low and will require replacement soon. With an alkaline battery, you may be able to get another 100+ shots before the battery drops to "Battery Low 2.")
- 2 Flashes = Battery Low 2 (Battery **MUST** be replaced to clear this status code.)
- 3 Flashes = Key switch in **OFF/DISABLED (O)** position when the safety mechanism was moved from the **S-SAFE** to the **F-FIRE** position. (Status code is cleared by moving the safety mechanism from the **F-FIRE** position to the **S-SAFE** position and turning the key switch to the **ON/ENABLED (I)** position.)
- 4 Flashes = Trigger was pulled when the safety mechanism was moved from the **S-SAFE** position to the **F-FIRE** position (Status code is cleared by cycling the safety mechanism from the **F-FIRE** position to the **S-SAFE** position.)
- 5 Flashes = Battery installed with the safety mechanism in the **F-FIRE** position (Status code is cleared by cycling the safety mechanism from the **F-FIRE** position to the **S-SAFE** position.)
- 6, 7, 8, 9, 10 and 11 Flashes = Factory Service Required. Do not attempt to use your firearm.

The Battery

The Model 700™ EtronX™ uses a conventional 9-volt battery located under the recoil pad. See Picture 7. For best all-around performance, Remington® recommends the use of an alkaline battery in the Model 700 EtronX.

TO REMOVE AND INSTALL THE BATTERY:

WARNING: Check the chamber and magazine to make sure there are no cartridges in the firearm.

NEVER attempt to remove or install a battery on a loaded firearm.

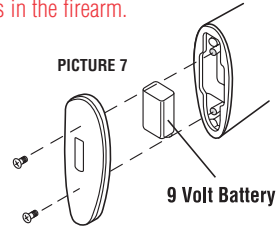

1. Point the firearm in a safe direction.
2. Put the safety mechanism in the **S-SAFE** position.
3. Turn the key switch to the **OFF/DISABLED (O)** position.
4. Using a Phillips screwdriver, loosen and remove both recoil pad screws and remove the recoil pad.
5. Remove the old battery.
6. Install the replacement battery as shown in Picture 7, making sure the + and - terminals on the battery match the corresponding terminal markings on the battery holder.
7. Replace the recoil pad and tighten both recoil pad screws. Be careful not to overtighten the recoil pad screws.

The Bolt Assembly

The bolt assembly locks the cartridge into the chamber.

TO INSTALL THE BOLT ASSEMBLY:

WARNING: Check the chamber and magazine to make sure there are no cartridges in the firearm.

NEVER attempt to install the bolt assembly on a loaded firearm.

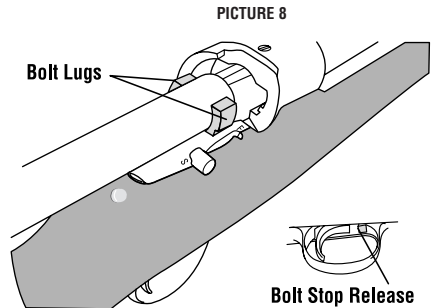

1. Point the firearm in a safe direction.
2. Put the safety mechanism in the **S-SAFE** position.
3. Turn the key switch to the **OFF/DISABLED (O)** position.
4. Align the lugs on the bolt assembly with the receiver. See Picture 8.
5. Slide the bolt assembly into the receiver and push all the way in.
6. To place the bolt assembly in closed position, push the bolt handle down.

TO REMOVE THE BOLT ASSEMBLY:

WARNING: Check the chamber and magazine to make sure there are no cartridges in the firearm.

NEVER attempt to remove the bolt assembly on a loaded firearm.

1. Point the firearm in a safe direction.
2. Put the safety mechanism in the **S-SAFE** position.
3. Turn the key switch to the **OFF/DISABLED (0)** position.
4. Raise the bolt handle.
5. Pull the bolt handle all the way back.
6. Push the bolt stop release. See Picture 8 on page 10.
7. As you push the bolt stop release, slide the bolt from the firearm.

Firearm Assembly and Disassembly

TO DISASSEMBLE:

WARNING: Check the chamber and magazine to make sure there are no cartridges in the firearm.

NEVER attempt to assemble or disassemble the bolt assembly on a loaded firearm.

1. Point the firearm in a safe direction.
2. Put the safety mechanism in the **S-SAFE** position.
3. Turn the key switch to the **OFF/DISABLED (0)** position.
4. Remove the bolt assembly. See instructions on this page.
5. Turn the rifle upside down.
6. Remove the screws from the trigger guard. See Picture 9.
7. Carefully lift the stock away from the action.

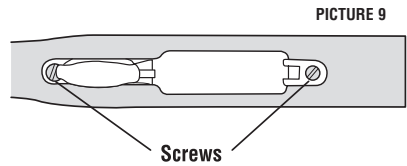

TO ASSEMBLE:

1. Put the magazine into the magazine recess in the receiver.
2. With the trigger guard removed, replace the stock over the action, carefully aligning the action's barrel lug with the lug cut in the stock.

NOTE: To prevent damage to the mating electrical connectors when reassembling the stock to the action, it is very important to align the action's barrel lug with the barrel lug cut in the stock and gently squeeze the components together (light finger pressure only). Failure to align the barrel lug with the barrel lug cut in the stock will misalign the connectors on the trigger assembly and the stock, possibly damaging the connectors. If more than finger pressure is required to squeeze the action and the stock together, it is an indication that the mating connectors are misaligned. Further pressure will damage the mating connectors.

3. Gently squeeze the action to the stock. The action is fully seated in the stock when the rear end of the receiver is resting completely against the bedding block in the stock.
4. Assemble the trigger guard to the stock.
5. Replace and tighten trigger guard screws.

WARNING: Before you replace the bolt assembly, make sure the barrel is free of obstructions.

6. Replace the bolt assembly. See instructions on pages 10 and 11.

The Trigger Assembly

Pulling the trigger fires the firearm.

WARNING: Never put your finger on the trigger unless, and until, you are going to fire the firearm.

TRIGGER ADJUSTMENT:

The trigger of your Model 700™ EtronX™ rifle has been preset at the factory in conformity with industry guidelines to have a trigger pull force of at least 3 pounds. However, for competition target shooters firing the rifle from a secure stationary rest in a controlled environment, the trigger pull force can be adjusted downward by the user or a qualified gunsmith using the procedure set forth below.

WARNING: Adjustment of the trigger pull force in this rifle below 3 pounds should only be made for a rifle to be used in competitive target shooting and fired from a secure stationary rest in a controlled environment. For any other purpose, including use in the field, the trigger pull force on your rifle should **NEVER** be reduced below 3 pounds. Remember – regardless of the amount of trigger pull force, **ALWAYS** keep the muzzle of your rifle pointed in a safe direction to prevent injury or death caused by an unintended or accidental discharge.

WARNING: Only the trigger pull force is adjustable. For safety's sake, **NEVER** make adjustments or alterations to any other parts of the trigger assembly or rifle.

TO ADJUST TRIGGER PULL FORCE:

WARNING: With the safety mechanism in the **S-SAFE** position, check the chamber and magazine of the rifle to make sure there are no cartridges in the rifle. **NEVER** attempt to adjust the trigger pull force on a loaded rifle.

1. Disassemble the firearm. See instructions on page 11.
2. Remove the magazine from the magazine recess in the bottom of the receiver.
3. Insert 1/16" hex key wrench into the trigger adjustment screw. See Picture 10.
4. Turning the trigger pull adjusting screw counterclockwise will lighten the trigger pull force. Turning the trigger pull adjusting screw clockwise will increase the trigger pull force.
5. Pull and release the trigger several times after each adjustment to reset the trigger pull force spring.
6. Check the trigger pull force with a force gauge or deadweight. An audible click can be heard from the trigger assembly when the trigger is pulled. The force measure when the click is heard is the trigger pull force.
7. Repeat step 6 several times to ensure the proper trigger pull force is maintained.

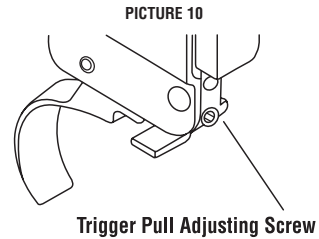

WARNING: If proper trigger pull weight can not be maintained from pull to pull, then return the firearm to the factory for service. Do not use your rifle if the trigger pull force can not be maintained.

8. Reassemble the firearm. See instructions on page 11.

WARNING: Be sure to note if you have adjusted the trigger pull force below 3 pounds when you store your rifle for any period of time. If you expect at any time to loan or sell your Model 700 EtronX rifle or to use the rifle for anything other than competition target shooting from a secure, stationary rest in a controlled environment, you should readjust the trigger pull force to at least 3 pounds.

The Barrel

The inside of the barrel must be clean and free of obstructions.

WARNING: Check the chamber and magazine to make sure there are no cartridges in the firearm.

I. TO CHECK THE INSIDE OF THE BARREL:

1. Point the firearm in a safe direction.
2. Put the safety mechanism in the **S-SAFE** position.
3. Turn the key switch to the **OFF/DISABLED (0)** position.
4. Raise the bolt handle.
5. Pull the bolt all the way back.
6. Remove any ammunition from the chamber or magazine. See page 14.
7. Remove the bolt. See page 11.
8. Look through the inside of the barrel from the chamber end to the muzzle. See Picture 1 on page 7.

II. TO REMOVE OBJECT FROM INSIDE THE BARREL:

1. Use the correct size cleaning rod.
2. Push the cleaning rod from the chamber end all the way through the barrel, until the rod comes out of the muzzle.
3. If an object can not be easily pushed out of the barrel with a cleaning rod, return the firearm to the factory or a REMINGTON® RECOMMENDED GUNSMITH.

WARNING: NEVER try to remove an object from the barrel by loading another cartridge and firing. This may cause the barrel to burst or a cartridge case to rupture and cause serious injury or death.

III. TO CLEAN THE BARREL, FOLLOW THE INSTRUCTIONS SHOWN ON PAGE 15.

To Load the Firearm

Before loading the firearm, make sure the inside of the barrel is free of dirt or other obstructions.

I. TO LOAD ONE CARTRIDGE ONLY:

WARNING: Use Remington ETRONX™ ammunition ONLY. Always check the cartridge for the correct caliber before loading the firearm.

1. Point the firearm in a safe direction.
2. Put the safety mechanism in the **S-SAFE** position.
3. Turn the key switch to the **OFF/DISABLED (O)** position.
4. Raise the bolt handle.
5. Pull the bolt handle all the way back.
6. Put one cartridge of the correct caliber on the magazine follower or in the chamber. See Picture 11.
7. Slide the bolt handle forward, then push the bolt handle down to lock the cartridge into the chamber.

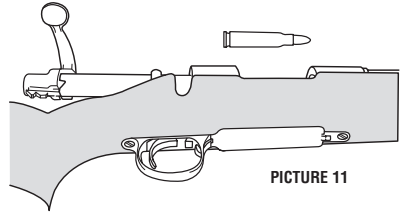

THE FIREARM IS NOW LOADED.

8. Turn the key switch to the **ON/ENABLED (I)** position.
9. To fire the firearm, put the safety mechanism in the **F-FIRE** position. The **LED** will turn **ON** solid when the firearm is ready to fire.

THE FIREARM IS READY TO FIRE.

NOTE: If the firearm is not fired within approximately 30 minutes, the system will put itself into a low power consumption mode. To reactivate the system:

1. Point the firearm in a safe direction.
2. Move the safety mechanism to the **S-SAFE** position.
3. Put the safety mechanism to the **F-FIRE** position.
4. When the **LED** turns **ON** solid, **THE FIREARM IS AGAIN READY TO FIRE.**

II. TO LOAD THE CHAMBER MAGAZINE:

WARNING: Use Remington ETRONX ammunition ONLY. Always check the cartridge for the correct caliber before loading the firearm.

1. Point the firearm in a safe direction.
2. Put the safety mechanism in the **S-SAFE** position.
3. Turn the key switch to the **OFF/DISABLED (O)** position.
4. Raise the bolt handle.
5. Pull the bolt handle all the way back.

SPECIAL NOTICE

Model 700 .220 SWIFT LOADING INSTRUCTIONS
Unlike other cartridges which are chambered in the Model 700, the .220 SWIFT is a semi-rimmed cartridge. Therefore, to ensure proper feeding, make sure that the rim of the top cartridge is **ahead** of the rim of the cartridge below.

RIGHT

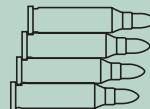

WRONG

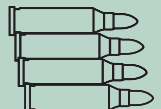

6. Push four cartridges of the correct caliber, one at a time, into the magazine. If the firearm is a magnum, you can only load three cartridges. If the firearm is a .17, .222 or .223 caliber, the magazine will hold five cartridges. Keep the bullets aligned toward the chamber. See Picture 11 on page 13.
7. Put one cartridge into the chamber.
8. Use your fingers to push the cartridges in the magazine all the way down. Slowly slide the colt assembly forward, so that the bolt slides over the top of the cartridges in the magazine.
9. Push the bolt handle down.

THE CHAMBER AND MAGAZINE ARE NOW FULLY LOADED.

10. Turn the key switch to the **ON/ENABLED (I)** position.
11. To fire the firearm, put the safety mechanism in the **F-FIRE** position.
12. When the **LED** turns **ON** solid, **THE FIREARM IS READY TO FIRE.**

NOTE: If the firearm is not fired within approximately 30 minutes, the system will put itself into a low power consumption mode. To reactivate the system:

1. Point the firearm in a safe direction.
2. Move the safety mechanism to the **S-SAFE** position.
3. Put the safety mechanism to the **F-FIRE** position.
4. When the **LED** turns **ON** solid. **THE FIREARM IS AGAIN READY TO FIRE.**

To Unload the Firearm

WARNING: Unload your firearm whenever you are not shooting.

1. Point the firearm in a safe direction.
2. Put the safety mechanism in the **S-SAFE** position.
3. Turn the key switch to the **OFF/DISABLED (O)** position.
4. Raise the bolt handle.
5. Put one hand over the top of the ejection port.
6. Slowly pull the bolt handle back with your other hand to remove the cartridge from the chamber.
7. Hold cartridge and remove it from the firearm.
8. Put your hand under the floor plate.
9. Push the floor plate latch to release the floor plate. See Picture 12. The magazine spring and follower will be released from the magazine.
10. Remove released cartridges.
11. Push in the magazine follower, then close the floor plate.

WARNING: Check the chamber and the magazine to make sure there are no cartridges in the firearm.

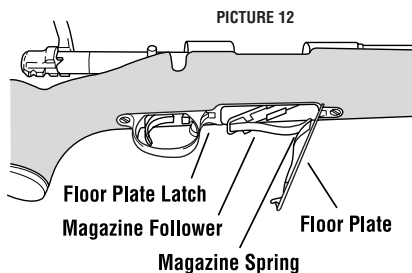

Lubrication and Maintenance

Over-lubrication should be avoided at all times. Remington® recommends the use of Rem™ Oil. Other oils and lubricants may have conductive properties that may interfere with the operations of the firearm. A thin coat of Rem™ Oil helps to prevent rusting. See note below.

When the firearm is to be stored, it should be cleaned and thoroughly oiled. While in storage, outside surfaces should be occasionally wiped with a light coat of Rem™ Oil. Remington also recommends that the battery be removed from the firearm when the firearm is stored for extended periods of time (see instructions on page 10).



When the firearm is to be used again after storage, all excess lubrication must be removed. The chamber and bore must be thoroughly wiped dry. Reinstall the battery in the firearm (see instructions on page 10).

NOTE: Remington Rem™ Oil is available from your local dealer. If your dealer is out of stock, ask them to order Rem™ Oil from their Remington distributor.

TO CLEAN THE BARREL:

WARNING: Check the chamber and magazine to make sure there are no cartridges in the firearm. Never try to clean a loaded firearm.

NOTE: Remington® recommends that chlorinated solvents **NOT** be used to clean this firearm.

1. Use the equipment provided in a good cleaning kit. For recommendations, see your Remington Authorized Gunsmith.
2. Point the muzzle of the firearm in a safe direction.
3. Put the safety mechanism in the **S-SAFE** position.
4. Turn the key to the **OFF/DISABLED (O)** position.
5. Remove the bolt assembly. See instructions on page 11.
6. Select the proper caliber cleaning brush and attach the brush to the cleaning rod.
7. Put the cleaning brush into the gun cleaning solvent.

NOTE: The barrel should lay horizontally with the ejection port facing down during cleaning. Always clean the barrel from the chamber end to the muzzle.

8. Push the cleaning brush through the barrel several times.
9. Remove brush from rod, attach tip with cleaning patch and push through the bore.
10. Repeat several times using a new cleaning patch each time, until the patch is not dirty.
11. Push a clean patch saturated with Rem™ Oil through the barrel.
12. Push a clean, dry patch through the barrel to remove excess lubricant.
13. Apply a thin coat of Rem™ Oil to the outside of the barrel with a soft cleaning cloth.
14. After cleaning the barrel, clean the receiver and the trigger assembly.

WARNING: This firearm should be checked periodically by Remington Arms Company, Inc. or a REMINGTON RECOMMENDED GUNSMITH. This will ensure proper inspection and any necessary replacement of worn or damaged parts.

TO CLEAN THE RECEIVER AND TRIGGER ASSEMBLY:

WARNING: Check the chamber and the magazine to make sure there are no cartridges in the firearm.

1. Disassemble the firearm. See instructions on page 11.

NOTE: Clean the receiver and trigger assembly as a unit with Rem™ Oil.

2. Spray the receiver and the one point of the trigger assembly with Rem™ Oil. See Picture 13. Let stand for 15 minutes. Spray again to wash off the components. Shake off any excess lubricant.

WARNING: Excessive use of a non-recommended lubricant could adversely affect the function and safe operation of your firearm.

PICTURE 13

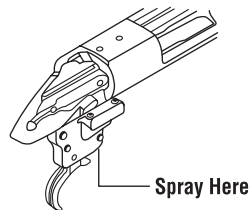

TO ASSEMBLE:

1. Reassemble the firearm. See instructions on page 11.

WARNING: After cleaning the trigger assembly, check the chamber and magazine to make sure there are no cartridges in the firearm. Pull the trigger. A click will be heard or felt when the trigger is pulled. If no click is heard or felt when the trigger is pulled, return the firearm to the factory or a REMINGTON RECOMMENDED GUNSMITH.

CLEANING FREQUENCY:

1. Before and after long-term storage.
2. When the rifle has been subjected to adverse conditions such as shooting in the rain, snow, sleet or saltwater areas.
3. When the rifle is exposed to dirty conditions such as lying on the ground outdoors, being dropped in the mud, etc.

NOTE: While the stainless steel versions of the Model 700™ Rifle have been designed and manufactured to provide improved corrosion protection, only proper care will keep your firearm in good operating condition and maintain the appearance. After extensive use, the protective coating on plated parts may be worn sufficiently to reduce corrosion protection. Such worn parts should be replaced to assure the integrity of the corrosion protection.

WARNING: After each use, follow the lubrication and maintenance directions in this instruction book. If the firearm is immersed, it must be thoroughly cleaned, dried and lubricated as soon as possible. To dry the stock, remove the action from the stock and remove the recoil pad and battery from the stock butt. Allow any water remaining in the stock to drain. Make sure the battery compartment and blindmate connectors are completely clean and dry before reinstalling the battery, recoil pad and action. In case of saltwater immersion, first flush all parts with freshwater, then dry, clean and lubricate the firearm. If the firearm does not function properly, return the firearm to the factory. Failure to obey this warning may lead to firearm malfunctions which could result in serious personal injury or death to you or others.

Instructions for Cleaning the Bolt Assembly

TO DISASSEMBLE THE BOLT ASSEMBLY:

WARNING: Check the chamber and magazine to make sure there are no cartridges in the firearm.

1. Point the firearm in a safe direction.
2. Put the safety mechanism in the **S-SAFE** position.
3. Turn the key switch to the **OFF/DISABLED (0)** position.
4. Remove the bolt assembly from the firearm. See instructions on page 11.
5. Pull rearward on the bolt plug detent with your thumb. See Picture 14.
6. The bolt plug is attached to the bolt with left-handed threads. Rotate the bolt plug clockwise and unscrew it from the bolt.
7. Slide the firing pin assembly from the bolt.
8. Pull the firing pin contact assembly rearward off of the firing pin insulator from the end of the firing pin. See Picture 15.
9. Clean all parts with gun-cleaning solvent. Dry with a clean cloth.

NOTE: Remington® recommends that chlorinated solvents **NOT** be used to clean this firearm.

10. Apply a thin coat of Rem™ Oil.

TO ASSEMBLE:

WARNING: Check the chamber and the magazine to make sure there are no cartridges in the firearm.

NEVER attempt to assemble the bolt assembly on a loaded firearm.

1. Put the firing pin contact assembly on the firing pin with the exposed portion of the contact pointing toward the rear of the firing pin. Make sure the firing pin insulator is still attached to the firing pin. See Picture 15.
2. Slide the firing pin assembly into the rear of the bolt, slipping the firing pin contact into the slot in the rear of the bolt. See Picture 16.
3. Insert the bolt plug into the rear of the bolt. Turn counterclockwise to tighten until the bolt plug detent snaps into the small notch at the rear of the bolt. See Picture 17. The bolt is now assembled.

NOTE: If the bolt plug is turned past the small notch, the bolt plug will hit the receiver when the bolt is assembled to the firearm.

4. Assemble the bolt assembly into the firearm. See instructions on page 10.

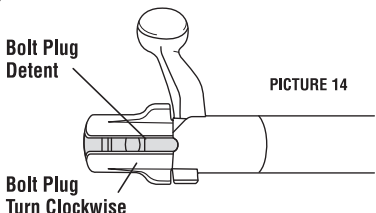

PICTURE 14

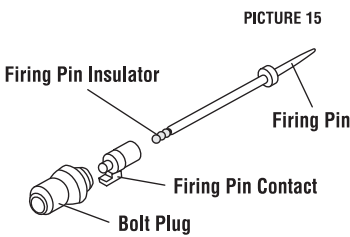

PICTURE 15

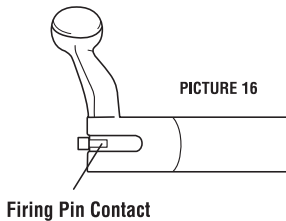

PICTURE 16

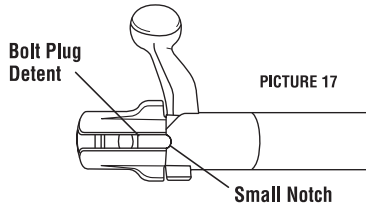

PICTURE 17

How to Obtain Parts and Service From Remington.®

TO ORDER PARTS:

Many Remington Dealers and Authorized Repair Centers carry a full line of parts. Please check with them first before ordering parts.

To expedite your PARTS order or request REPAIR SERVICE visit our Web site at www.remington.com. Detailed instructions are provided along with parts and/or service order forms. You may also reach Remington by calling our toll free customer service number, 1-800-243-9700, Mon.-Fri., 9:00 AM-5:00 PM Eastern time.

1. Fax completed order form (obtainable from the Web site) to 1-336-548-7801.
2. To order by phone without the order form call 1-877-ETRONX1.

Please have the following information ready before you call.

- Firearm model and serial number.
- Part description and quantity. Part descriptions can be found on the parts listing page in this manual.
- Your complete mailing address (P.O. Box and street address), including zip code, day-time telephone number and e-mail address.
- Method of payment: MasterCard, VISA, Amex or Discover card number and expiration date. Prepayment may be made by check or money order. A quote may be made to you over the phone. (Sorry, no C.O.D.s.)

WARNING: USE ONLY REMINGTON ETRONX PARTS IN REMINGTON ETRONX FIREARMS.

NOTE: SOME PARTS MAY BE RESTRICTED. See parts list for details. Owner's manuals/instruction books may be requested via our Web site at www.remington.com or by calling 1-877-ETRONX1.

REPAIR SERVICES

1. To obtain repair information on your Model 700™ EtronX™ firearm, visit our Web site at www.remington.com and select "Support" from "Obtaining Service."

Print the "Repair Order" provided and package with the firearm.

- Record the serial number of your firearm before sending it to us.
- Pack your firearm for safety and to prevent further damage in shipping and handling. Preferably, ship in a firearm box.
- Remove all accessories from the firearm to prevent loss or damage.
- Enclose a letter with the firearm detailing the serial number along with a full description of the problem. Be sure to include your full name and address (P.O. Box and street address), including zip code, day-time telephone number and e-mail address.
- Ship your firearm by either United Parcel Service (UPS) or Parcel Post (US Post Office). Remington is not responsible for damage or loss during shipment, so you may elect to purchase insurance from your carrier.

Ship to:

Remington Arms Company, Inc.
Arms Service Department ETRONX
14 Hoefler Ave.
Ilion, NY 13357

WARNING! DO NOT SEND LIVE OR SPENT SHELLS IN YOUR FIREARM OR IN THE SAME BOX WITH THE FIREARM. THIS IS A VIOLATION OF FEDERAL LAW. IF YOU FEEL YOU MUST SEND SPENT SHELLS, PLEASE SEND THEM IN A SEPARATE PACKAGE AND INCLUDE NAME, ADDRESS (WITH ZIP CODE), TELEPHONE NUMBER, MODEL AND SERIAL NUMBER OF YOUR FIREARM.

- EtronX firearms sent to Remington Arms Co. Inc., will be given priority attention in order to provide you with the most effective and efficient service possible.

MODEL 700™ ETRONX™

Bolt Action Centerfire Rifle

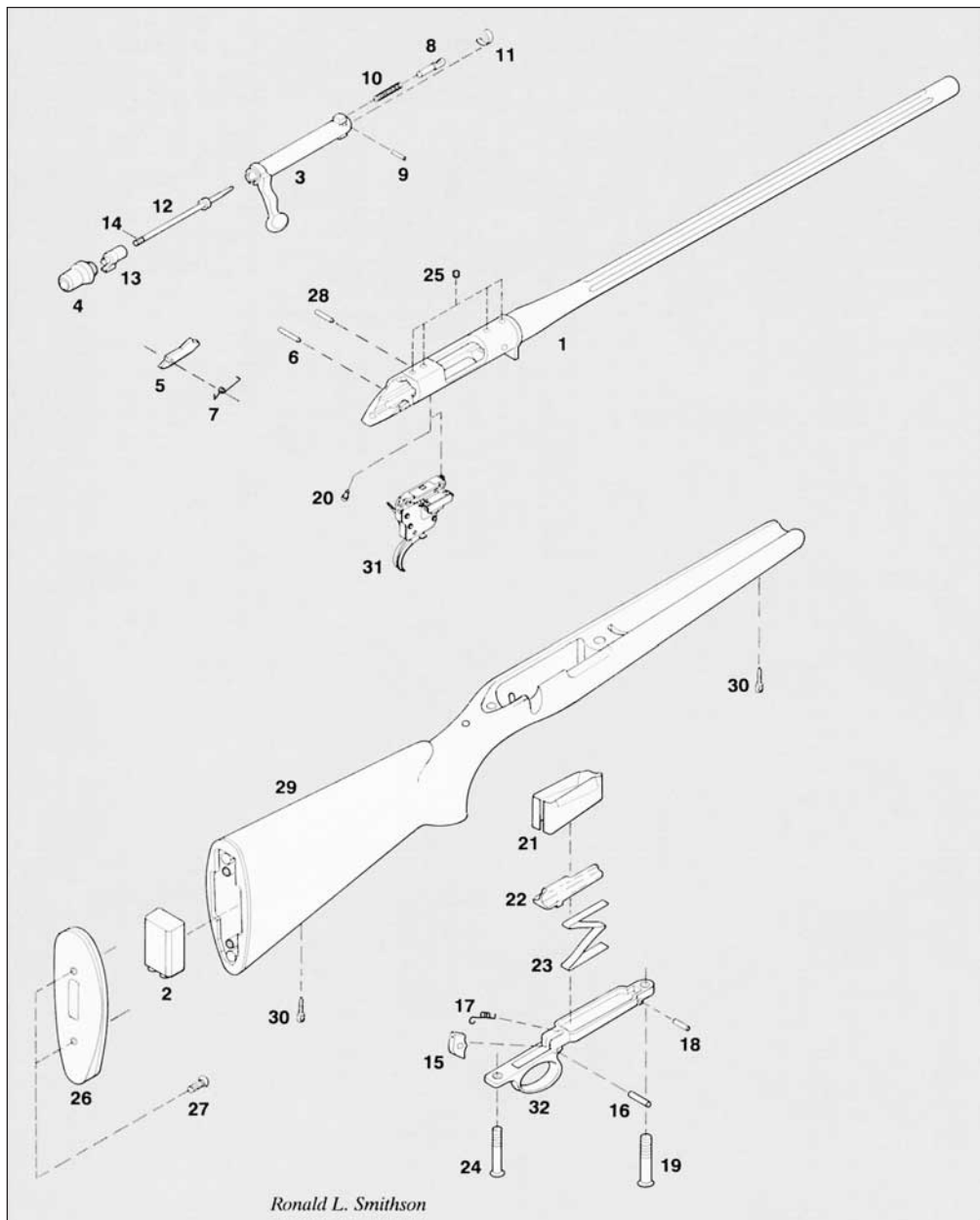

Ronald L. Smithson

MODEL 700™ ETRONX™

Bolt Action Centerfire Rifle

PARTS LIST

VIEW #	PART NAME
1	Barrel Assembly (Restricted)
2	Battery
3	Bolt Assembly (Restricted)
4	Bolt Plug Assembly (Restricted)
5	Bolt Stop (Restricted)
6	Bolt Stop Pin (Restricted)
7	Bolt Stop Spring (Restricted)
8	Ejector
9	Ejector Pin
10	Ejector Spring
11	Extractor
12	Firing Pin Assembly (Restricted)
13	Firing Pin Contact Assembly
14	Firing Pin Insulator
15	Floor Plate Latch
16	Floor Plate Latch Pin
17	Floor Plate Latch Spring
18	Floor Plate Pivot Pin
19	Front Guard Screw
20	Grounding Screw
21	Magazine
22	Magazine Follower
23	Magazine Spring
24	Rear Guard Screw
25	Receiver Plug Screw
26	Recoil Pad (Restricted)
27	Recoil Pad Screw
28	Sear Pin (Restricted)
29	Stock Assembly (Restricted)
30	Swivel Screw (2)
31	Trigger Assembly (Restricted)
32	Trigger Guard Assembly

WARNING: Before troubleshooting, check the chamber and the magazine to make sure there are no cartridges in the firearm.

TROUBLESHOOTING GUIDE

PROBLEM	POSSIBLE CAUSES	POSSIBLE SOLUTIONS
LED flashes 1 time.	<ul style="list-style-type: none"> • Low battery voltage. 	<ul style="list-style-type: none"> • Replace battery.
LED flashes 2 times.	<ul style="list-style-type: none"> • Battery is dead. 	<ul style="list-style-type: none"> • Replace battery.
LED flashes 3 times.	<ul style="list-style-type: none"> • Key switch in the OFF/DISABLED (0) position when safety mechanism moved from the S-SAFE to F-FIRE position. 	<ul style="list-style-type: none"> • Move safety mechanism from F-FIRE back to S-SAFE. Turn key switch to ON/ENABLE (I). Then move the safety mechanism back to the F-FIRE position.
LED flashes 4 times.	<ul style="list-style-type: none"> • Trigger pulled when safety mechanism was moved from S-SAFE to F-FIRE. 	<ul style="list-style-type: none"> • Cycle safety mechanism from F-FIRE to S-SAFE and then back to F-FIRE with your finger off the trigger.
		<ul style="list-style-type: none"> • Check for and relieve any binding of the trigger between mating components such as trigger guard.
		<ul style="list-style-type: none"> • Trigger switch is damaged. Factory service is required.
LED flashes 5 times.	<ul style="list-style-type: none"> • Battery was installed with the safety mechanism in the F-FIRE position. 	<ul style="list-style-type: none"> • Cycle safety mechanism from F-FIRE to S-SAFE and then back to F-FIRE with your finger off the trigger.
LED flashes 6, 7, 8, 9, 10 or 11 times.	<ul style="list-style-type: none"> • Malfunction in the on-board electronics. 	<ul style="list-style-type: none"> • Factory service is required. Do not attempt to use your firearm. Please note the number of flashes in the letter of explanation accompanying the firearm when it is returned for service.
Cartridge chambered but LED does not illuminate.	<ul style="list-style-type: none"> • Safety mechanism in S-SAFE position. 	<ul style="list-style-type: none"> • Move safety mechanism to F-FIRE position.
	<ul style="list-style-type: none"> • No battery in the firearm. 	<ul style="list-style-type: none"> • Unload the firearm following the instructions on page 14. Install the battery following the instructions on page 10.
	<ul style="list-style-type: none"> • Firing pin not touching the primer. 	<ul style="list-style-type: none"> • Firing pin is bound rearward. Unload the firearm following the instructions on page 14. Disassemble the bolt following the instructions on page 16 and verify the firing pin moves freely. If it does not, contact Remington® for service, noting the condition in the letter of explanation accompanying the firearm when it is returned for service. • Cartridge's primer contact is misaligned with the firing pin. Replace with a new cartridge. • Cartridge's primer contact is obstructed. Replace with a new cartridge.

WARNING: Before troubleshooting, check the chamber and the magazine to make sure there are no cartridges in the firearm.

TROUBLESHOOTING GUIDE (Continued)

PROBLEM	POSSIBLE CAUSES	POSSIBLE SOLUTIONS
Cartridge chambered but LED does not illuminate.	<ul style="list-style-type: none"> • Ammunition problem. 	<ul style="list-style-type: none"> • Replace with a new cartridge.
	<ul style="list-style-type: none"> • Battery installed with polarity reversed. 	<ul style="list-style-type: none"> • Unload the firearm following the instructions on page 14. Reinstall the battery following the instructions on page 10, paying close attention to the battery polarity (the large diameter terminal on the battery is the negative (-) terminal).
LED goes out when trigger is pulled, but cartridge does NOT fire.	<ul style="list-style-type: none"> • Firing pulse to round shorted. 	<ul style="list-style-type: none"> • Unload the firearm following the instructions on page 14. Disassemble and clean the bolt and firing pin following the instructions on page 16. Reassemble the bolt following the instructions on page 16.
		<ul style="list-style-type: none"> • With the bolt removed from the action, wipe the top of the trigger assembly with a clean cloth to remove any fouling or debris. Replace the bolt, reload and try firing the cartridge again.
		<ul style="list-style-type: none"> • With the bolt out of the action, move the safety mechanism from S-SAFE to F-FIRE. If the LED illuminates, return the firearm to the factory for service. Please note the condition in the letter of explanation accompanying the firearm when it is returned for service.
	<ul style="list-style-type: none"> • Ammunition problem. 	<ul style="list-style-type: none"> • Replace with a new cartridge.
	<ul style="list-style-type: none"> • Firing pin insulator missing. 	<ul style="list-style-type: none"> • Unload the firearm following the instructions on page 14. Disassemble the bolt and firing pin following the instructions on page 16. Verify the firing pin insulator is installed on the rear of the firing pin. Replace the firing pin insulator if it is missing. Reassemble the firing pin and bolt following the instructions on page 16.
<ul style="list-style-type: none"> • Firing pin is damaged. 	<ul style="list-style-type: none"> • Return the firearm to the factory for service. Please note the condition in the letter accompanying the firearm when it is returned for service. 	

WARNING: Before troubleshooting, check the chamber and the magazine to make sure there are no cartridges in the firearm.

TROUBLESHOOTING GUIDE (Continued)

PROBLEM	POSSIBLE CAUSES	POSSIBLE SOLUTIONS
LED turns ON solid when bolt is closed on empty chamber.	<ul style="list-style-type: none"> Firing circuit is shortened. 	<ul style="list-style-type: none"> Bolt and/or firing pin assembly is fouled. Unload the firearm following the instructions on page 14. Disassemble and clean the bolt and firing pin following the instructions on page 16. Reassemble the bolt following the instructions on page 16.
	<ul style="list-style-type: none"> Firing pin insulator missing. 	<ul style="list-style-type: none"> Unload the firearm following the instructions on page 14. Disassemble the bolt and firing pin following the instructions on page 16. Verify the firing pin insulator is installed on the rear of the firing pin. Replace the firing pin insulator if it is missing. Reassemble the firing pin and bolt following the instructions on page 16.
	<ul style="list-style-type: none"> Firing pin is damaged. 	<ul style="list-style-type: none"> Return the firearm to the factory for service. Please note the condition in the letter of explanation accompanying the firearm when it is returned for service.
LED turns ON solid or flickers when bolt is moved.	<ul style="list-style-type: none"> Bolt touching trigger assembly contact. 	<ul style="list-style-type: none"> Lift the bolt handle and pull the bolt partway back. If the LED flickers when the bolt is moved, return the firearm to the factory for service. Please note the condition in the letter of explanation accompanying the firearm when it is returned for service.
LED turns ON solid when bolt is open.	<ul style="list-style-type: none"> Bolt touching trigger assembly contact. 	<ul style="list-style-type: none"> With the bolt out of the action, move the safety mechanism from S-SAFE to F-FIRE. If the LED illuminates, return the firearm to the factory for service. Please note the condition in the letter of explanation accompanying the firearm when it is returned for service.
LED turned ON solid when bolt is out of the firearm.	<ul style="list-style-type: none"> Firing circuit is shorted. 	<ul style="list-style-type: none"> Factory service is required. Please note the condition in the letter of explanation accompanying the firearm when it is returned for service.
LED turned ON solid with the safety mechanism in the S-SAFE position.	<ul style="list-style-type: none"> Electronics or cabling failure. 	<ul style="list-style-type: none"> Factory service is required. Please note the condition in the letter of explanation accompanying the firearm when it is returned for service.

Firearm Owner's Record

Model _____ Serial # _____ Date Purchased _____

Purchased From _____ Price Paid _____

Remember to complete and return the Firearm Warranty Registration Card in order to obtain full benefit of your Limited Two Year Firearm Warranty.

A WORD ON THE MAINTENANCE AND CARE OF YOUR REMINGTON FIREARM

Don't Alter or Modify Your Gun and Have it Serviced Regularly.

Your firearm has been designed to operate according to certain factory specifications. You'll jeopardize your safety and that of others around you by attempting to alter its trigger, mechanical safety or other mechanisms. So never alter or modify your firearm in any way.

Like any mechanical device, a firearm is subject to wear. It must be maintained and periodically serviced to assure optimum safety and performance. Only a qualified service facility should service, repair or modify your Remington® firearm. Consult your instruction book for instructions on how to send your firearm to the factory or for the location of the nearest Remington repair station. Remington recommends that you have your firearm professionally serviced annually. You should also have your firearm professionally serviced after prolonged storage, or if there is ever any question pertaining to the proper functioning characteristics of your firearm.

Proper cleaning and lubrication are also important to firearm maintenance and are necessary to assure accuracy, safety and reliability. Before cleaning, always make sure that your gun is completely unloaded. And always clean the barrel from the chamber end to the muzzle when possible.

Firearm Maintenance Record

DATE	SERVICE PERFORMED	PERFORMED BY

Remington®

REMINGTON IS A TRADEMARK REGISTERED IN THE UNITED STATES PATENT AND TRADEMARK OFFICE BY REMINGTON ARMS COMPANY, INC.